

311C Utility Hydraulic Excavator



Engine

Engine Model	Cat 3064T	
Gross Power	61 kW	82 hp
Flywheel Power	59 kW	79 hp

Weights

Operating Weight*	11 980 kg	26,410 lb
-------------------	-----------	-----------

Swing Mechanism

Swing Torque	31 270 N.m	23,060 lb ft
--------------	------------	--------------

*Standard undercarriage, 2800 mm (9' 2") stick and 500 mm (20") shoes.

311C Utility Hydraulic Excavator

Increased horsepower, better controllability, extended service intervals and a redesigned operator station increase your productivity and lower your operating costs.

Engine

The 311C U is powered by the Cat® 3064 T engine. This engine includes several design features which enhance performance, efficiency and reliability.
pg. 4

Hydraulics

The open-center, two-pump hydraulic system features pump flow control which improves fuel efficiency, ensures smooth controllability, reduces sound levels and extends component life.
pg. 5

Undercarriage and Structures

Rugged Caterpillar® undercarriage design and proven structural manufacturing techniques assure outstanding durability in the toughest applications. New grease lubricated seals protect and prolong track life.
pg. 6

Complete Customer Support

Your Cat dealer offers a wide range of services that can be set up under a customer support agreement when you purchase your equipment. The dealer will help you choose a plan that can cover everything from machine and attachment selection to replacement.
pg. 11

Increased horsepower, better controllability, extended service intervals and a redesigned operator station increase your productivity and lower your operating costs.



Front Linkage

Designed-in flexibility to help bring higher production and efficiency to all jobs. **pg. 8**

Operator Station

✓ Larger, quieter, climate-controlled cab has excellent sightlines to the work area to help keep operator fatigue low and production up throughout the entire shift. **pg. 9**

Serviceability

✓ Longer service intervals and easier maintenance result in better machine availability and lower owning and operating costs. **pg. 10**



✓ *New Feature*

Engine

The four cylinder turbocharged Cat 3064 T engine is built for power, reliability, economy and low emissions.



Torque Rise. The engine is designed for high torque rise at middle rpm, a feature that is especially beneficial for heavy-duty use.

Cylinder Block. The cylinder block is cast iron for improved wear resistance. The upper part is laser hardened to reduce oil consumption and internal component wear.

Maintenance. The oil level gauge, oil filter, fuel filter and priming pump are located on the right side of the upper structure for easy maintenance. The engine oil filter and fuel filter change intervals have been extended.

Crankshaft. The eight balance, one-piece, forged crankshaft enhances balance and decreases vibration and is induction hardened to improve abrasion resistance.

Pistons. Heat resistant aluminum alloy pistons have a short compression height, reducing weight and improving efficiency.

Fuel Consumption. The 3064 T engine has the best fuel consumption in this class of diesel engines. It features improved thermal efficiency and reduced friction resistance between piston and liners.

Air Intake Heating. Air intake heating is standard on the 311C U for easier cold starts.

Hydraulics

Caterpillar hydraulics deliver power and control to keep material moving at high volume.

Component Layout. The 311C U hydraulic system was designed to provide a high level of efficiency. With all major components located close together, shorter tubes and lines are needed, resulting in less friction loss in the lines and reduced pressure drops.

Hydraulic Cross Sensing System. Improves productivity with faster implement speeds and quicker, stronger pivot turns.

Automatic Boom and Swing Priority. For simpler operation, work mode and power mode switches have been eliminated. Instead, the automatic boom and swing priority function selects the best mode, based on joystick movement.

Stackable Valves. Up to two additional control valves can be added to the main control valve of the 311C U to run additional tools.

Controllability. The hydraulic system offers precise control to the 311C U, reducing operator fatigue, improving operator effectiveness and efficiency, which ultimately translates into enhanced performance.

Auxiliary Hydraulic Valve. For further versatility, a dedicated hammer (single function), thumb (double function), and combined auxiliary hydraulics are offered on the 311C U.



Hydraulic Snubbers. Hydraulic cylinder snubbers at the rod-end of boom cylinders and both ends of the stick cylinders cushion shocks, reduce sound and increase cylinder life.

Undercarriage and Structures

Durable undercarriage absorbs stresses and provides excellent stability.



Structures. The 311C U structural components and undercarriage are the backbone of the machine's durability.

Rollers and Idlers. Sealed and lubricated track rollers, carrier rollers and idlers provide excellent service life, to keep the machine in the field longer.

Main Frame. The rugged main frame is designed for maximum durability and efficient use of materials.

Grease Lubricated Track. New grease lubricated seals protect the track link and deliver long track link pin and bushing inner wear life.

Travel Motors. Automatic speed selection enables the machine to automatically change up and down from high and low speeds in a smooth, controlled manner.

Idler Guard. An idler guard, which is integral to the track roller frame is standard. This guard helps maintain track alignment while traveling or working on slopes.



Carbody Design and Track Roller Frames. X-shaped, box-section carbody provides excellent resistance to torsional bending. Robot-welded track roller frames are press-formed, pentagonal units to deliver exceptional strength and service life.

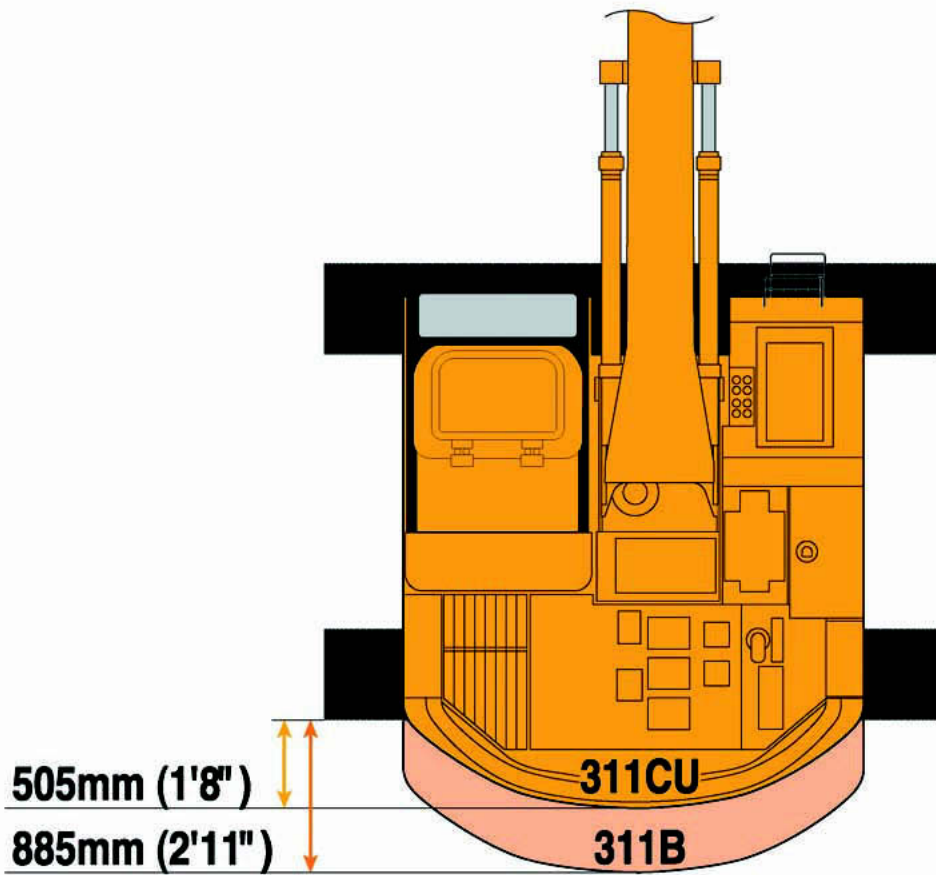

Blades. For further versatility and to meet more general purposes needs, three blade width options are available on the 311C U.

Shorter Tail Swing Radius. The 311C U, with its reduced tail swing radius, is easier to operate while against walls and in tight areas, reducing the concern of the rear of

the machine during operation. The shorter tail measurement allows flexibility for ideal use in urban construction, logging roads, and other space restricted sites.

Front Linkage

Designed-in flexibility to help bring higher production and efficiency to all jobs.



Front Linkage. Front linkage variations on the 311C U allow for the use of one boom, two sticks and five buckets. Using these combinations improves the general-purpose versatility of the 311C U by suiting it to a diverse range of applications.

Boom. The boom on the 311C U is designed to provide maximum digging capability. Caterpillar booms are manufactured with high-tensile steel for upper, lower and side plates and robot welded for consistent quality.

Stick. Two sticks are available on the 311C U. The customer's working envelope and bucket capacity needs determine their stick choice.

Boom and Stick Construction. Built for performance and long service life, Caterpillar booms and sticks are large, welded, box-section structures with thick, multi-plate fabrications in high-stress areas.

Buckets. High tensile strength steel is used in high-stress areas for excellent wear and shock resistance. The excavation bucket is designed for general-purpose excavation and to have a large bucket capacity and tip radius.

Bucket Linkage. The bucket linkage on the 311C U includes the bucket cylinder, idler link and power links.

Linkage Bearings. New bearing technology has extended the front linkage greasing intervals for all bearings.

Operator Station

Designed for simple operation, the 311C U operator station allows the operator to focus on production.

Operator Environment. The 311C U operator work station is quiet with ergonomic control placement and convenient adjustments, low lever and pedal effort, ergonomic seat design and highly efficient ventilation.

Monitor. The 311C U's newly designed and conveniently located monitor allows the operator to monitor machine performance while sitting in a comfortable position.

Automatic Boom and Swing Priority Function. For simpler operation, work mode and power mode switches have been eliminated. Instead, the automatic boom and swing priority function selects the best mode, based on joystick movement.

Redesigned Layout. Redesigned cab layout emphasizes simplicity and ease of use. Right-hand wall and console provide easy access to all switches, dials and controls.

Travel Controls. A large rubber-covered footrest at the side of the travel pedals allows the foot to easily grip the pedal. The travel lever stroke and force have been enhanced to improve the 311C U's fine controllability, making the machine easier to operate.

Seat. A new seat with a two-tone color offers two types of cushions - soft and firm - for operator comfort. The reclining knob is located at the right-side of the seat for easier reclining adjustment.



Automatic Climate Control. Fully automatic climate control adjusts temperature and flow and determines which air outlet is best in each situation.

Skylight. A large polycarbonate skylight delivers excellent natural lighting and good ventilation. Standard sliding sunshade protects from direct sunlight.

Serviceability

Simplified service and maintenance features save you time and money.



Extended Service Intervals. 311C U service and maintenance intervals have been extended to reduce machine service time and increase machine availability.

Radiator Compartment. The left rear service door allows easy access to the engine radiator and the oil cooler. A reserve tank and drain cock are attached to the radiator for simplified maintenance.

Air Filter Compartment. The air filter features a double-element construction for superior cleaning efficiency. When the air cleaner plugs, a red warning sign appears on the indicator near the air cleaner.

Ground Level Service. The design and layout of the 311C U was made with the service technician in mind. Many service locations are easily accessible at ground level allowing critical maintenance to get done quickly and efficiently.



Pump Compartment. A service door on the right side of the upper structure allows ground-level access to the pump and pilot filter.

Capsule Filter. The hydraulic return filter, a capsule filter, is situated outside the hydraulic tank. This filter prevents contaminants from entering the system when hydraulic oil is changed and keeps the operation clean.

Anti-Skid "Punched-Star" Plate. Anti-skid punched-star plate covers the maintenance walkway to prevent slipping. The plate can be removed for cleaning.

Complete Customer Support

Cat dealer services help you operate longer with lower costs.

Selection. Make detailed comparisons of the machines you are considering before you buy. What are the job requirements? What production is needed? What is the true cost of lost production? Your Cat dealer can give you precise answers to these questions.

Purchase. Look past initial price, look at the value the 311C U offers. Consider the financing options available as well as day-to-day operating costs.

Operation. Improving operating techniques can boost your profits. Your Cat dealer has training literature and other ideas to help you increase productivity.

Maintenance. Repair option programs guarantee the cost of repairs up front. Diagnostic programs such as Scheduled Oil Sampling and Technical Analysis help you avoid unscheduled repairs.

Replacement. Repair, rebuild or replace? Your Cat dealer can help you evaluate the cost involved so you can make the right choice.

Product Support. You will find nearly all parts at our dealer parts counter. Cat dealers utilize a worldwide computer network to find in-stock parts to minimize machine down time. You will save money with remanufactured components.



Engine

Engine Model	Cat 3064T	
Gross Power	61 kW	82 hp
Flywheel Power	59 kW	79 hp
ISO 9249	59 kW	79 hp
SAE J1349	59 kW	79 hp
EEC 80/1269	59 kW	79 hp
Bore	102 mm	4 in
Stroke	130 mm	5.1 in
Displacement	4.25 L	259 in ³

Weights

Operating Weight	11 980 kg	26,410 lb
------------------	-----------	-----------

- Standard undercarriage, 2800 mm (9' 2") stick and 500 mm (20") shoes.

Swing Mechanism

Swing Torque	31 270 N.m	23,060 lb ft
Swing Speed	10.6 RPM	

Drive

Travel Speed	5.6 kph	3.4 mph
Max. Drawbar Pull	92 kN	20,680 lb

Hydraulic System

Main Implement System - Max. Flow (2x)	108 L/min	28 gal/min
Max. Pressure - Implements	29 900 kPa	4,340 psi
Max. Pressure - Travel	34 300 kPa	4,980 psi
Max Pressure - Swing	23 500 kPa	3,410 psi
Pilot System - Max. Flow	24.3 L/min	6.4 gal/min
Pilot System - Max. Pressure	4120 kPa	600 psi
Blade - Max. Flow	53.2 L/min	14.1 gal/min
Blade System - Max Pressure	20 594 kPa	2,990 psi
Boom Cylinder - Bore	100 mm	4 in
Boom Cylinder - Stroke	1002 mm	40 in
Stick Cylinder - Bore	110 mm	4.3 in
Stick Cylinder - Stroke	1194 mm	47 in
Bucket Cylinder - Bore	100 mm	4 in
Bucket Cylinder - Stroke	939 mm	37 in

Service Refill Capacities

Fuel Tank	195 L	51.5 gal
Cooling System	17.5 L	4.6 gal
Engine Oil	19.5 L	5.2 gal
Swing Drive	3 L	0.8 gal
Final Drive (Each)	3 L	0.8 gal
Hydraulic System (Including Tank)	160 L	42.3 gal
Hydraulic Tank	92 L	24.3 gal

Standards

Meets the following standards:

Cab/FOGS	SAE J1356 FEB88 ISO 10262
----------	------------------------------

Sound Performance

The operator sound exposure Leq (equivalent sound pressure level) measured according to the work cycle procedures specified in ANSI/SAE J1166 OCT98 is 74 dB(A), for the cab offered by Caterpillar, when properly installed and maintained and tested with the doors and windows closed.

Hearing protection may be needed when operating with an open operator station and cab (when not properly maintained or doors/windows open) for extended periods or in noisy environment.

Dimensions

All dimensions are approximate.

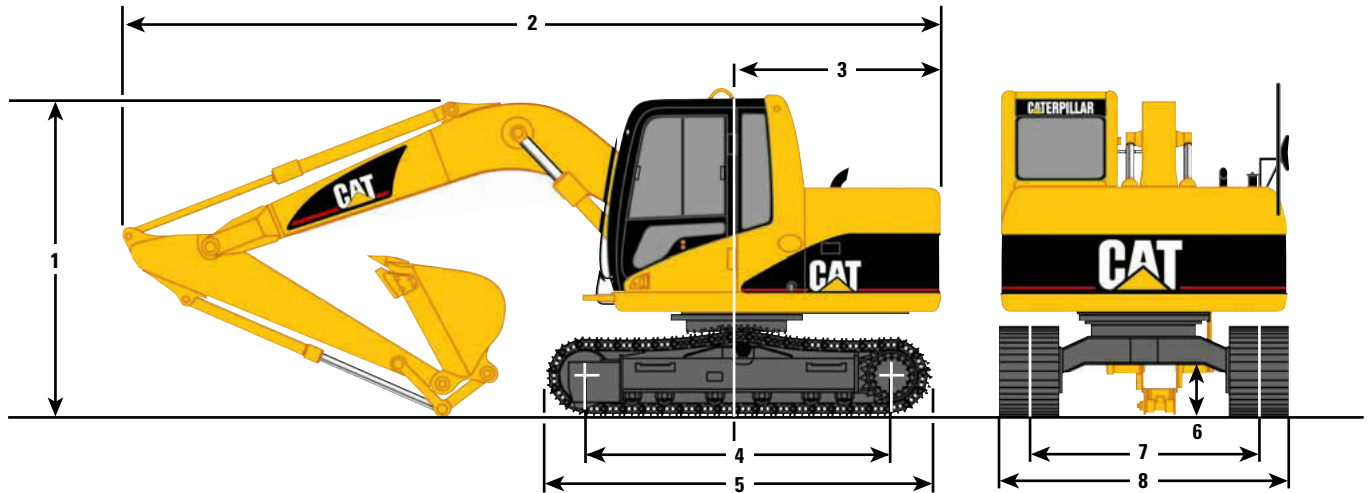

Boom 4.3 m (14'1")		2250 mm (7'5") Stick	2800 mm (9'2") Stick		
1	Shipping height	2770 mm (9'1")	2770 mm (9'1")		
2	Shipping length	6910 mm (22'8")	6920 mm (22'8")		
3	Tail swing radius	1750 mm (5'9")	1750 mm (5'9")		
4	Length to centers of rollers	2610 mm (8'7")	2610 mm (8'7")		
5	Track length	3320 mm (10'11")	3320 mm (10'11")		
6	Ground clearance	445 mm (1'5")	445 mm (1'5")		
7	Track gauge	1990 mm (6'6")	1990 mm (6'6")		
8	Transport width	with 500 mm (20") 2490 mm (8'2")	with 600 mm (24") 2590 mm (8'6")	with 700 mm (28") 2690 mm (8'10")	with 770 mm (30") 2760 mm (9'1")

Operating Weights

Caterpillar designed and built track-type undercarriage.

Track width		Operating Weight (medium stick)		Operating Weight (long stick)	
standard	500 mm (20") triple grouser	11 940 kg	(26,325 lb)	11 980 kg	(26,410 lb)
optional	600 mm (24") triple grouser	12 160 kg	(26,810 lb)	12 200 kg	(26,900 lb)
	700 mm (28") triple grouser	12 390 kg	(27,315 lb)	12 430 kg	(27,405 lb)
	770 mm (30") triple grouser	12 510 kg	(27,580 lb)	12 550 kg	(27,670 lb)
	Blade: add	830 kg	(1830 lb)		

Working Ranges

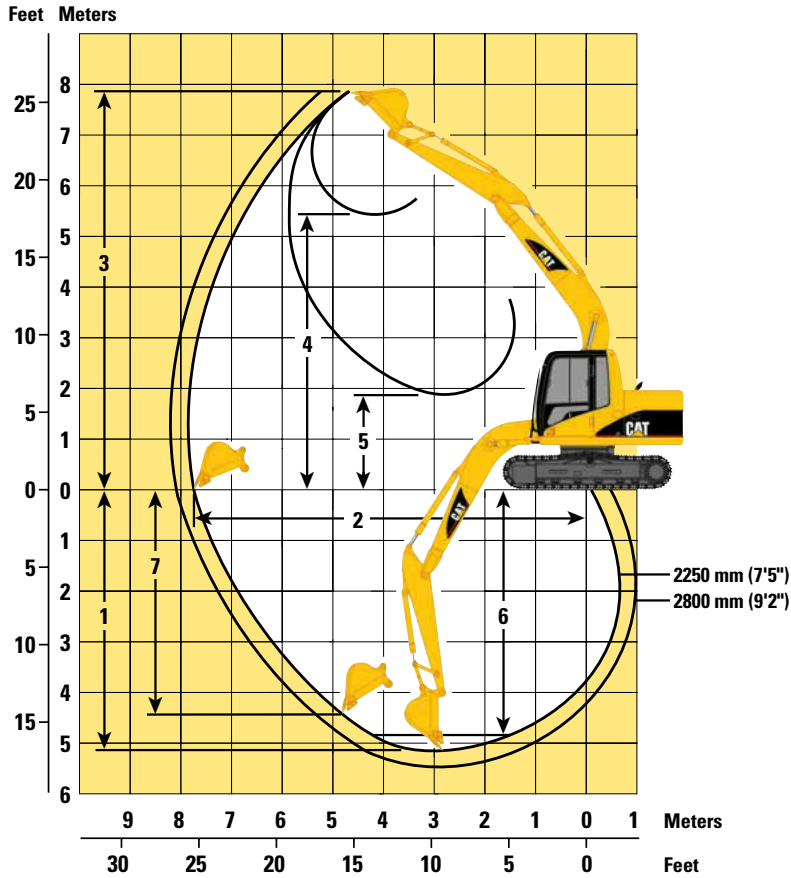

Stick Length	2250 mm (7'5")*	2800 mm (9'2")**
1 Maximum Digging Depth	5040 mm (16'6")	5590 mm (18'4")
2 Maximum Reach at Ground Level	7570 mm (24'10")	8100 mm (26'7")
3 Maximum Cutting Height	7805 mm (25'7")	8125 mm (26'8")
4 Maximum Loading Height	5450 mm (17'11")	5770 mm (18'11")
5 Minimum Loading Height	1880 mm (6'2")	1340 mm (4'5")
6 Maximum Depth Cut for 2440 mm (8') Level Bottom	4815 mm (15'10")	5440 mm (17'10")
7 Maximum Vertical Wall Digging Depth	4425 mm (14'6")	4940 mm (16'2")
Stick Digging Force (SAE)	58 kN (13,000 lb)	50 kN (11,000 lb)
Bucket Digging Force (SAE)	80 kN (18,000 lb)	80 kN (18,000 lb)

* – Measurements shown are for machines equipped with the 0.40 m³ (0.53 yd³) bucket

** – Measurements shown are for machines equipped with the 0.30 m³ (0.39 yd³) bucket

Buckets

Buckets have tapered sides, angled corner teeth, dual radius curvature, horizontal wear strips, and holes for optional side cutters.

Width		Capacity		Recommended Maximum Material Density			
				Medium Stick		Long Stick	
mm	in	m ³	yd ³	kg/m ³	lbs/yd ³	kg/m ³	lbs/yd ³
610	24	0.30	0.39	1800	3000	1800	3000
760	30	0.40	0.53	1800	3000	1800	3000
910	36	0.52	0.68	1800	3000	1500	2500
1070	42	0.63	0.82	1500	2500	1200	2000
1220	48	0.74	0.97	1200	2000	900	1500

Material Densities

Material	kg/m ³ *	lbs/yd ³ **	Material	kg/m ³ *	lbs/yd ³ **
Clay, dry	1480	2500	Gravel, pit run	1930	3250
Clay, wet	1660	2800	Rock/dirt, 50%	1720	2900
Earth, dry	1510	2550	Sand, dry	1420	2400
Earth, wet	1600	2700	Sand, wet	1840	3100
Loam	1250	2100	Sand & Clay	1600	2700
Gravel, dry	1510	2550	Stone, crushed	1600	2700
Gravel, wet	2020	3400	Top soil	950	1600

* - kilograms per loose cubic meter

** - pounds per loose cubic yard

For densities of other materials see Caterpillar Performance Handbook

Undercarriage

Caterpillar designed and built track-type undercarriage.

Track width	(with triple grouser shoes)	Ground Pressure (Average)
standard	500 mm (20")	41.0 kPa (5.95 psi)
optional	600 mm (24") triple grouser	34.8 kPa (5.05 psi)
	700 mm (28") triple grouser	30.4 kPa (4.41 psi)
	770 mm (30") triple grouser	27.9 kPa (4.05 psi)

Reach Boom Lift Capacities

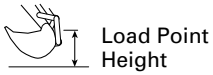

Load Point Height



Load at Maximum Reach



Load Radius Over Front















Load Radius Over Side

R2.25 STICK – 2250 mm (7'5")
BUCKET – 0.40 m³ (0.53 yd³)

UNDERCARRIAGE – Standard
SHOES – 500 mm (20") triple grouser

BOOM – 4300 mm (14'1")
BLADE – Up













	1.5 m (5.0 ft)		3.0 m (10.0 ft)		4.5 m (15.0 ft)		6.0 m (20.0 ft)				m ft	
												
6.0 m 20.0 ft	kg lb				*2500 *5000	*2500 *5000				*1050 *2350	*1050 *2350	5.87 18.96
4.5 m 15.0 ft	kg lb				*2650 *5750	*2650 *5750				*1000 *2150	*1000 *2150	6.86 22.41
3.0 m 10.0 ft	kg lb			*4150 *8900	*4150 *8900	*3200 *6900	2950 6350	2250 4750	1800 3850	*1000 *2150	*1000 *2150	7.34 24.04
1.5 m 5.0 ft	kg lb			*6200 *13,350	5200 11,150	3450 7450	2750 5900	2150 4600	1750 3700	*1050 *2300	*1050 *2300	7.41 24.31
Ground Line	kg lb			6450 13,800	4850 10,350	3300 7050	2600 5550	2100 4450	1650 3550	*1200 *2650	*1200 *2650	7.10 23.29
-1.5 m -5.0 ft	kg lb	*4900 *10,950	*4900 *10,950	6400 13,600	4750 10,200	3200 6900	2550 5400			*1550 *3350	1550 3350	6.34 20.76
-3.0 m -10.0 ft	kg lb	*8600 *19,350	*8600 *19,350	*6150 *13,200	4850 10,450	3250 7000	2600 5550			*2350 *5250	*2350 *5250	4.91 15.91

* Limited by hydraulic capacity rather than tipping load. The above loads are in compliance with SAE hydraulic excavator lift capacity rating standard J1097. They do not exceed 87% of hydraulic lifting capacity or 75% of tipping capacity. Weight of all lifting accessories must be deducted from the above lifting capacities.

R2.25 STICK – 2250 mm (7'5")
BUCKET – 0.40 m³ (0.53 yd³)

UNDERCARRIAGE – Standard
SHOES – 500 mm (20") triple grouser

BOOM – 4300 mm (14'1")
BLADE – Down

	1.5 m (5.0 ft)		3.0 m (10.0 ft)		4.5 m (15.0 ft)		6.0 m (20.0 ft)				m ft	
												
6.0 m 20.0 ft	kg lb				*2500 *5000	*2500 *5000				*1050 *2350	*1050 *2350	5.87 18.96
4.5 m 15.0 ft	kg lb				*2650 *5750	*2650 *5750				*1000 *2150	*1000 *2150	6.86 22.41
3.0 m 10.0 ft	kg lb			*4150 *8900	*4150 *8900	*3200 *6900	2950 6350	*2850 *6050	1800 3850	*1000 *2150	*1000 *2150	7.34 24.04
1.5 m 5.0 ft	kg lb			*6200 *13,350	5200 11,150	*3950 *8550	2750 5900	*3100 *6750	1750 3700	*1050 *2300	*1050 *2300	7.41 24.31
Ground Line	kg lb			*7250 *15,700	4850 10,350	*4550 *9800	2600 5550	*3350 *7250	1650 3550	*1200 *2650	*1200 *2650	7.10 23.29
-1.5 m -5.0 ft	kg lb	*4900 *10,950	*4900 *10,950	*7150 *15,500	4750 10,200	*4650 *10,050	2550 5400			*1550 *3350	1550 3350	6.34 20.76
-3.0 m -10.0 ft	kg lb	*8600 *19,350	*8600 *19,350	*6150 *13,200	4850 10,450	*3950 *8400	2600 5550			*2350 *5250	*2350 *5250	4.91 15.91

* Limited by hydraulic capacity rather than tipping load. The above loads are in compliance with SAE hydraulic excavator lift capacity rating standard J1097. They do not exceed 87% of hydraulic lifting capacity or 75% of tipping capacity. Weight of all lifting accessories must be deducted from the above lifting capacities.

Reach Boom Lift Capacities



Load Point Height



Load at Maximum Reach



Load Radius Over Front















Load Radius Over Side

R2.25 STICK – 2250 mm (7'5")
BUCKET – 0.40 m³ (0.53 yd³)

UNDERCARRIAGE – Standard
SHOES – 700 mm (28") triple grouser

BOOM – 4300 mm (14'1")
BLADE – Up













	1.5 m (5.0 ft)		3.0 m (10.0 ft)		4.5 m (15.0 ft)		6.0 m (20.0 ft)				m ft	
												
6.0 m 20.0 ft	kg lb				*2500 *5000	*2500 *5000			*1050 *2350	*1050 *2350	5.87 18.96	
4.5 m 15.0 ft	kg lb				*2650 *5750	*2650 *5750			*1000 *2150	*1000 *2150	6.86 22.41	
3.0 m 10.0 ft	kg lb			*4150 *8900	*4150 *8900	*3200 *6900	3050 6600	2300 4950	1850 4000	*1000 *2150	*1000 *2150	7.34 24.04
1.5 m 5.0 ft	kg lb			*6200 *13,350	5400 11,550	3600 7700	2850 6150	2250 4800	1800 3850	*1050 *2300	*1050 *2300	7.41 24.31
Ground Line	kg lb			6700 14,300	5000 10,750	3400 7300	2700 5800	2150 4650	1750 3700	*1200 *2650	*1200 *2650	7.10 23.29
-1.5 m -5.0 ft	kg lb	*4900 *10,950	*4900 *10,950	6600 14,150	4950 10,600	3350 7150	2650 5650			*1550 *3350	*1550 *3350	6.34 20.76
-3.0 m -10.0 ft	kg lb	*8600 *19,350	*8600 *19,350	*6150 *13,200	5050 10,800	3400 7300	2700 5750			*2350 *5250	*2350 *5250	4.91 15.91

* Limited by hydraulic capacity rather than tipping load. The above loads are in compliance with SAE hydraulic excavator lift capacity rating standard J1097. They do not exceed 87% of hydraulic lifting capacity or 75% of tipping capacity. Weight of all lifting accessories must be deducted from the above lifting capacities.

R2.25 STICK – 2250 mm (7'5")
BUCKET – 0.40 m³ (0.53 yd³)

UNDERCARRIAGE – Standard
SHOES – 700 mm (28") triple grouser

BOOM – 4300 mm (14'1")
BLADE – Down

	1.5 m (5.0 ft)		3.0 m (10.0 ft)		4.5 m (15.0 ft)		6.0 m (20.0 ft)				m ft	
												
6.0 m 20.0 ft	kg lb					*2500 *5000	*2500 *5000			*1050 *2350	*1050 *2350	5.87 18.96
4.5 m 15.0 ft	kg lb					*2650 *5750	*2650 *5750			*1000 *2150	*1000 *2150	6.86 22.41
3.0 m 10.0 ft	kg lb			*4150 *8900	*4150 *8900	*3200 *6900	3050 6600	*2850 *6050	1850 4000	*1000 *2150	*1000 *2150	7.34 24.04
1.5 m 5.0 ft	kg lb			*6200 *13,350	5400 11,550	*3950 *8550	2850 6150	*3100 *6750	1800 3850	*1050 *2300	*1050 *2300	7.41 24.31
Ground Line	kg lb			*7250 *15,700	5000 10,750	*4550 *9800	2700 5800	*3350 *7250	1750 3700	*1200 *2650	*1200 *2650	7.10 23.29
-1.5 m -5.0 ft	kg lb	*4900 *10,950	*4900 *10,950	*7150 *15,500	4950 10,600	*4650 *10,050	2650 5650			*1550 *3350	*1550 *3350	6.34 20.76
-3.0 m -10.0 ft	kg lb	*8600 *19,350	*8600 *19,350	*6150 *13,200	5050 10,800	*3950 *8400	2700 5750			*2350 *5250	*2350 *5250	4.91 15.91

* Limited by hydraulic capacity rather than tipping load. The above loads are in compliance with SAE hydraulic excavator lift capacity rating standard J1097. They do not exceed 87% of hydraulic lifting capacity or 75% of tipping capacity. Weight of all lifting accessories must be deducted from the above lifting capacities.

Reach Boom Lift Capacities



Load Point Height



Load at Maximum Reach



Load Radius Over Front















Load Radius Over Side

R2.8 STICK – 2800 mm (9'2")
BUCKET – 0.30 m³ (0.39 yd³)

UNDERCARRIAGE – Standard
SHOES – 500 mm (20") triple grouser

BOOM – 4300 mm (14'1")
BLADE – Up













	1.5 m (5.0 ft)		3.0 m (10.0 ft)		4.5 m (15.0 ft)		6.0 m (20.0 ft)				m ft	
												
6.0 m 20.0 ft	kg lb									*850 *1900	*850 *1900	6.55 21.22
4.5 m 15.0 ft	kg lb							*2100 *4200	1900 4000	*800 *1750	*800 *1750	7.43 24.28
3.0 m 10.0 ft	kg lb					*2800 *6050	*2800 *6050	2300 4850	1850 3950	*800 *1750	*800 *1750	7.86 25.77
1.5 m 5.0 ft	kg lb			*5450 *11,750	5400 11,550	3550 7550	2800 6050	2200 4650	1750 3750	*850 *1850	*850 *1850	7.93 26.02
Ground Line	kg lb			6550 14,000	4900 10,500	3300 7100	2600 5600	2100 4450	1650 3550	*1000 *2100	*1000 *2100	7.65 25.09
-1.5 m -5.0 ft	kg lb	*4250 *9500	*4250 *9500	6350 13,550	4750 10,150	3200 6850	2500 5350	2050 4350	1600 3450	*1200 *2650	*1200 *2650	6.97 22.81
-3.0 m -10.0 ft	kg lb	*7000 *15,700	*7000 *15,700	6400 13,650	4750 10,200	3200 6850	2500 5400			*1750 *3900	*1750 *3900	5.72 18.60
-4.5 m -15.0 ft	kg lb			*4600 *4600						*3400 *3400	*3400 *3400	3.78

* Limited by hydraulic capacity rather than tipping load. The above loads are in compliance with SAE hydraulic excavator lift capacity rating standard J1097. They do not exceed 87% of hydraulic lifting capacity or 75% of tipping capacity. Weight of all lifting accessories must be deducted from the above lifting capacities.

R2.8 STICK – 2800 mm (9'2")
BUCKET – 0.30 m³ (0.39 yd³)

UNDERCARRIAGE – Standard
SHOES – 500 mm (20") triple grouser

BOOM – 4300 mm (14'1")
BLADE – Down

	1.5 m (5.0 ft)		3.0 m (10.0 ft)		4.5 m (15.0 ft)		6.0 m (20.0 ft)				m ft	
												
6.0 m 20.0 ft	kg lb									*850 *1900	*850 *1900	6.55 21.22
4.5 m 15.0 ft	kg lb							*2100 *4200	1900 4000	*800 *1750	*800 *1750	7.43 24.28
3.0 m 10.0 ft	kg lb					*2800 *6050	*2800 *6050	*2550 *5550	1850 3950	*800 *1750	*800 *1750	7.86 25.77
1.5 m 5.0 ft	kg lb			*5450 *11,750	5400 11,550	*3650 *7850	2800 6050	*2900 *6300	1750 3750	*850 *1850	*850 *1850	7.93 26.02
Ground Line	kg lb			*6950 *15,050	4900 10,500	*4350 *9400	2600 5600	*3250 *7000	1650 3550	*1000 *2100	*1000 *2100	7.55 25.09
-1.5 m -5.0 ft	kg lb	*4250 *9500	*4250 *9500	*7300 *15,750	4750 10,150	*4650 *10,050	2500 5350	*3350 *7150	1600 3450	*1200 *2650	*1200 *2650	6.97 22.81
-3.0 m -10.0 ft	kg lb	*7000 *15,700	*7000 *15,700	*6650 *14,350	4750 10,200	*4300 *9250	2500 5400			*1750 *3900	*1750 *3900	5.72 18.60
-4.5 m -15.0 ft	kg lb			*4600 *4600						*3400 *3400	*3400 *3400	3.78

* Limited by hydraulic capacity rather than tipping load. The above loads are in compliance with SAE hydraulic excavator lift capacity rating standard J1097. They do not exceed 87% of hydraulic lifting capacity or 75% of tipping capacity. Weight of all lifting accessories must be deducted from the above lifting capacities.

Reach Boom Lift Capacities



Load Point Height



Load at Maximum Reach



Load Radius Over Front















Load Radius Over Side

R2.8 STICK – 2800 mm (9'2")
BUCKET – 0.30 m³ (0.39 yd³)

UNDERCARRIAGE – Standard
SHOES – 700 mm (28") triple grouser

BOOM – 4300 mm (14'1")
BLADE – Up













	1.5 m (5.0 ft)		3.0 m (10.0 ft)		4.5 m (15.0 ft)		6.0 m (20.0 ft)				m ft	
												
6.0 m 20.0 ft	kg lb									*850 *1900	*850 *1900	6.55 21.22
4.5 m 15.0 ft	kg lb							*2100 *4200	1950 4150	*800 *1750	*800 *1750	7.43 24.28
3.0 m 10.0 ft	kg lb					*2800 *6050	*2800 *6050	2350 5050	1900 4100	*800 *1750	*800 *1750	7.86 25.77
1.5 m 5.0 ft	kg lb			*5450 *11,750	*5450 *11,750	*3650 7850	2900 6250	2250 4850	1850 3900	*850 *1850	*850 *1850	7.93 26.02
Ground Line	kg lb			6800 14,500	5100 10,900	3450 7350	2700 5800	2200 4650	1750 3700	*1000 *2100	*1000 *2100	7.65 25.09
-1.5 m -5.0 ft	kg lb	*4250 *9500	*4250 *9500	6600 14,050	4900 10,550	3300 7100	2600 5600	2150 4550	1700 3600	*1200 *2650	*1200 *2650	6.97 22.81
-3.0 m -10.0 ft	kg lb	*7000 *15,700	*7000 *15,700	6650 14,150	4950 10,600	3350 7150	2600 5600			*1750 *3900	*1750 *3900	5.72 18.60
-4.5 m -15.0 ft	kg lb			*4600	*4600					*3400	*3400	3.78

* Limited by hydraulic capacity rather than tipping load. The above loads are in compliance with SAE hydraulic excavator lift capacity rating standard J1097. They do not exceed 87% of hydraulic lifting capacity or 75% of tipping capacity. Weight of all lifting accessories must be deducted from the above lifting capacities.

R2.8 STICK – 2800 mm (9'2")
BUCKET – 0.30 m³ (0.39 yd³)

UNDERCARRIAGE – Standard
SHOES – 700 mm (28") triple grouser

BOOM – 4300 mm (14'1")
BLADE – Down

	1.5 m (5.0 ft)		3.0 m (10.0 ft)		4.5 m (15.0 ft)		6.0 m (20.0 ft)				m ft	
												
6.0 m 20.0 ft	kg lb									*850 *1900	*850 *1900	6.55 21.22
4.5 m 15.0 ft	kg lb							*2100 *4200	1950 4150	*800 *1750	*800 *1750	7.43 24.28
3.0 m 10.0 ft	kg lb					*2800 *6050	*2800 *6050	*2550 *5550	1900 4100	*800 *1750	*800 *1750	7.86 25.77
1.5 m 5.0 ft	kg lb			*5450 *11,750	*5450 *11,750	*3650 7850	2900 6250	*2900 *6300	1850 3900	*850 *1850	*850 *1850	7.93 26.02
Ground Line	kg lb			*6950 *15,050	5100 10,900	*4350 *9400	2700 5800	*3250 *7000	1750 3700	*1000 *2100	*1000 *2100	7.65 25.09
-1.5 m -5.0 ft	kg lb	*4250 *9500	*4250 *9500	*7300 *15,750	4900 10,550	*4650 *10,050	2600 5600	*3350 *7150	1700 3600	*1200 *2650	*1200 *2650	6.97 22.81
-3.0 m -10.0 ft	kg lb	*7000 *15,700	*7000 *15,700	*6650 *14,350	4950 10,600	*4300 *9250	2600 5600			*1750 *3900	*1750 *3900	5.72 18.60
-4.5 m -15.0 ft	kg lb			*4600	*4600					*3400	*3400	3.78

* Limited by hydraulic capacity rather than tipping load. The above loads are in compliance with SAE hydraulic excavator lift capacity rating standard J1097. They do not exceed 87% of hydraulic lifting capacity or 75% of tipping capacity. Weight of all lifting accessories must be deducted from the above lifting capacities.

Standard Equipment

Alternator, 50 amp

One touch low idle

Automatic swing brake

Automatic work modes

Auxiliary hydraulic valve (1)

Bolt-on Falling Objects Guard System (FOGS) capability

Cab

- AM/FM radio, 24-volt
- Ashtray with cigar lighter
- Air Conditioner with defroster
- Drink holder
- Floor mat
- Horn
- Hydraulic neutralizer lever for all controls
- Instrument panel and gauges
- Joysticks, adjustable pilot-operated
- Light, interior
- Light, box mounted (1)
- Literature holder
- Openable front windshield
- Openable skylight
- Suspension seat
- Travel control pedals with removable hand levers

Doors and caps lock with one-key security system

Mirrors (frame and cab)

Powertrain

- Cat 3064T diesel engine
- 24-volt electric starting
- Air intake heater
- Water separator

Undercarriage

- 20" (500 mm) triple grouser shoes
- Hydraulic track adjusters
- Idler section track guiding guards
- Track-type undercarriage with grease lubricated seals

Optional Equipment

Air prefilter	KAB 527 seat with heater
Auxiliary hydraulics - for hydraulic hammer and thumb (combined)	Power supply 12V-5A
Auxiliary hydraulics for hydraulic hammer	Rain protector
Auxiliary hydraulics for hydraulic thumb	Rear window with external opening provisions (mandatory in British Columbia)
Auxiliary hydraulic lines for booms and sticks	Right side boom lights
Blade, 8'2" (2500 mm) with replaceable cutting edges (for 20" (500 mm) triple grouser shoes)	Secondary exit, rear window (mandatory in certain countries)
Blade, 8'6" (2600 mm) with replaceable cutting edges (for 24" (600 mm) triple grouser shoes)	Steel side bumpers
Blade, 8'10" (2700 mm) with replaceable cutting edges (for 28" (700 mm) and 30" (770 mm) triple grouser shoes)	Stick and boom combinations: <ul style="list-style-type: none">- 14'1" (4.3 m) boom with left side light- 9'2" (2.8 m) stick- 7'5" (2.25 m) stick
Bucket linkage	Straight travel pedal
Cab fan	Sun visor
Cab front mesh guard for use with hammers	Swivel guard
Cab mounted working lights	Track: <ul style="list-style-type: none">- 24" (600 mm) triple grouser shoes- 28" (700 mm) triple grouser shoes- 30" (770 mm) triple grouser shoes- 20" (500 mm) segment rubber track
Cab with polycarbonate windows (mandatory in certain countries)	Track guiding guard, center
Cold weather start	Travel alarm (mandatory in certain countries)
Falling Objects Guard System	Vandalism protection
Front windshield guard	
Hand control pattern changer	
Heavy-duty bottom guard	
High ambient cooling system	
KAB 527 seat	

Notes

311C Utility Hydraulic Excavator

For more complete information on Cat products, dealer services, and industry solutions, visit us on the web at www.CAT.com

© 2001 Caterpillar
Printed in U.S.A.

AEHQ5432 (5-01)

Materials and specifications are subject to change without notice.
Featured machines in photos may include additional equipment.
See your Caterpillar dealer for available options.

CATERPILLAR[®]